

ELECTRO-LUBER™

INSTALLATION INSTRUCTIONS MICRO, MINI, BUDGET & JUMBO

Working Principle

When one or a combination of selector switches are turned on, an electro-chemical reactor cell is activated. This begins an electro-chemical reaction whereby electrical energy is converted into nitrogen gas. The gas is trapped in a hermetically sealed bellows type gas chamber. As the gas is produced, an internal pressure builds up, which is applied against a piston. The piston then forces the lubricant out of the cylinder and into the lube point. The strength of the electrical current determines the amount of gas produced, which in turn, controls the rate of lubricant flow and the length of time the ELECTRO-LUBER™ will operate.

General Information

On first installation, using a hand grease gun and the same type of grease, pump a few shots of lubricant into the bearing. If fittings or grease lines are used, these also should be filled with the same lubricant. This step need not be repeated when changing the ELECTRO-LUBER™.

Install the ELECTRO-LUBER™, if possible, directly on the bearing. The ELECTRO-LUBER™ MINI LUBER has 1/4" NPT threads, the BUDGET and JUMBO LUBER have 1/2" NPT threads. To mount the ELECTRO-LUBER™ on bearings with different thread sizes use standard plumbing adapters or adapters available from **A.T.S.**

For remote installation of ELECTRO-LUBERS™ filled with grease use up to 3 feet of pipe or tubing with a minimum 1/4" ID (3/8" preferred). If oil is being used, line length may be up to 15 feet. Oil filled lubricators must be mounted with outlet pointed upward to avoid lubricant running out. If mounting oil filled lubricators with the outlet pointing downward, they must be used with a low pressure check valve.

High temperature lubricants, with an NLGI 2 rating, tend to harden at low temperatures and the lubricator cannot push them out. In low temperature applications use Lowtemp lubricants with NLGI 0 or 1 rating.

Each ELECTRO-LUBER™ is supplied with a **weather proof switch cap with O-Ring which must be installed and tightened in all cases** as protection against weather and moisture. This cap **must** be kept on to insure the intrinsic safety rating of the unit.

To insure the success of your ELECTRO-LUBER™ installation, do not use in temperatures exceeding 130 degrees Fahrenheit, or in an application requiring more than 50 psi. The ELECTRO-LUBER™ is a single point lubricator and is not designed to feed more than one bearing.

Warning: Wait 30 seconds after removing switch cap before operating any switches to ensure venting of the battery chamber.

Starting Procedure

Select the dispensing time and amount of lubricant required, then click the appropriate switch or switches. This action closes a circuit and the gas generation begins.

Also click on the "LIGHT" switch. The LED light will soon flash and will repeat every 15 to 20 seconds for as long as the circuit is closed. The presence of the LED light assures that the system is in working order.

With the ELECTRO-LUBER, **after the circuit is closed, there is a delay** before enough gas is formed to start moving the piston. The longer the dispensing period, the longer the delay.

If continuous uninterrupted lubrication is required, "prestart" the ELECTRO-LUBER for 12 hours with all switches in the "ON" position. After this time return all switches to the "OFF" position except the ones for the chosen dispensing rate.

If you do not "prestart" the delay time will be:

	Time Delay to Dispense				
Month switch Setting	1 mo	2 mo	3mo	6 mo	12 mo
Delay in Hours To Start	18-24	40-48	60-70	120-140	240-280

1. Time selector switches, resistors and electronic circuit board.
2. Battery chamber with 2 x 1.5 volt alkaline batteries.
3. Electrochemical cell and electrolyte.
4. Bellow gas chamber.
5. Piston.
6. Lubricant reservoir.
7. Cylinder - nylon.
8. Mounting nipple.
9. Outer plug.
10. "O" ring.
11. Switch panel cap.

1 year shelf life

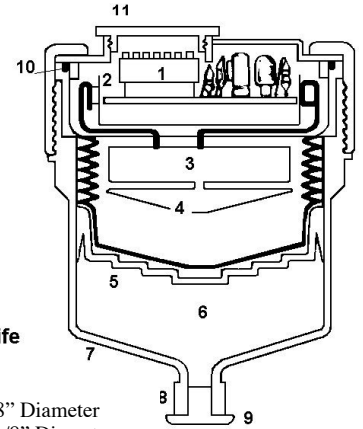

MICRO-LUBER dimensions 5" High x 3 1/8" Diameter
MINI-LUBER dimensions: 5 5/8" High x 3 1/8" Diameter
BUDGET-LUBER dimensions: 6 1/4" High x 4" Diameter
JUMBO-LUBER dimensions: 6 3/4" High x 4 3/4" Diameter

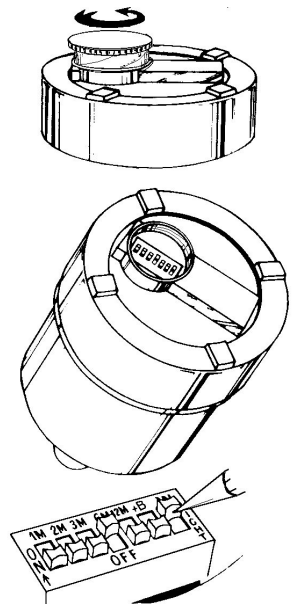

Operating Procedure

If it is desired to increase or decrease the lubricant dispensing rate during operations, simply click the switch in use to OFF, Then click on the new switch setting.

To turn OFF the ELECTRO-LUBER™ during periods of shutdown click all switches, including the “LIGHT” switch, to OFF. It is not necessary to turn off the lubricator before disposal, simply remove from the bearing and dispose with your other used grease products.

Removing an ELECTRO-LUBER™ during operation will permit the discharge of lubricant until the point equilibrium in the expandable gas chamber is reached. In a bearing with no back pressure no discharge will occur.

To Prevent Accidents

DO NOT DISMANTLE DISCHARGED ELECTRO-LUBER™ (UNDER PRESSURE UP TO 50 PSI) WITHOUT FIRST PUNCTURING A HOLE THROUGH THE BOTTOM OUTLET (GREASE OUTLET), THROUGH THE PISTON AND INTO THE GAS CHAMBER TO RELIEVE THE PRESSURE.

Comparison Chart

This chart compares the lubricant output rate of the ELECTRO-LUBER™ with several common manual lubrication schedules. The ELECTRO-LUBER™ switch setting indicated will provide comparable lubrication to that of the manual practice shown. Do not over-lubricate bearings.

Manual Lubrication Schedule	MINI LUBER Setting		BUDGET LUBER Setting		JUMBO LUBER Setting	
	Unit Life	Switch Setting	Unit Life	Switch Setting	Unit Life	Switch Setting
Daily lubrication 3 – 4 strokes	1 month		2 months		4 months	
2 –3 lubrication 3 – 4 strokes	2 months		4 months		8 months	
Weekly lubrication 8 – 10 strokes	3 months		6 months		12 months	
Bi-weekly lubrication 8 –10 strokes	6 months		12 months			
Monthly lubrication 8 – 10 strokes	12 months					





A “Rule of Thumb” for Switch Setting



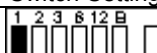

This chart offers a “Rule for Thumb” for selecting appropriate switch settings and lubricant output rates for some basic applications. Many variables must be considered when determining the best setting for your operating environment. Areas of high contamination and heavy water washout generally require a slight increase in lubricant flow rate. The settings shown below are based on an average ambient operating temperature of 68° Fahrenheit. Please consult the temperature chart on the following page for using your ELECTRO-LUBER™ in other temperature ranges. Because of the wide number of variables found in actual operating environments, this chart should only be considered as a guide in making a selection of the proper switch settings. ALWAYS AVOID OVER-LUBRICATING.

Bearing Shaft Size	MINI LUBER	
	Switch Setting	Days to Empty
4 ¾” to 6 ½”		15
4” to 4 ¾”		30
3 ¼” to 4”		60
2 ¾” to 3 ¼”		90
2 ¼” to 2 ¾”		180
1 ¾” to 2 ¼”		360

NOTE: Not responsible for consequential damage beyond replacement of ELECTRO-LUBER™ or refund of amount paid.

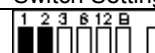
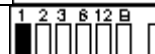
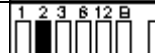
"Rule of Thumb" continued

Bearing Shaft Size	BUDGET LUBER	
	Switch Setting	Days to Empty
4 3/4" to 6 1/2"		30
4" to 4 3/4"		60
3 1/4" to 4"		120
2 3/4" to 3 1/4"		180
2 1/4" to 2 3/4"		360

Bearing Shaft Size	JUMBO LUBER	
	Switch Setting	Days to Empty
12 to 14 3/4"		20
10 3/4" to 12"		30
8 1/2" to 10 3/4"		60
6 1/2" to 8 1/2"		90
4" to 6 1/2"		120
2 3/4" to 4"		360

Adjustment for Temperature Variation

The ELECTRO-LUBER™ dispensing rate is calculated at 20° C (68° F) at sea level, and 14.7 PSI/G. However, as the temperature RISES, the dispensing rate INCREASES. As the temperature FALLS, the dispensing rate DECREASES. To calculate the dispensing rate of the ELECTRO-LUBER™ dispenser at higher or lower average temperatures refer to the following chart, and apply the factor to the charts on the last page.

	°F	°C	FACTOR			
Red Ring MOST EFFECTIVE OPERATING TEMPERATURES	+131°	+55°	+35%	Standard dispenser – maximum working life 90 days at 55° C (131° F)		
	+113°	+45°	+30%			
	+104°	+40°	+20%			
	+95°	+35°	+15%			
	+86°	+30°	+10%			
	+77°	+25°	+5%			
	+68°	+20°	Stable			
	Blue Ring MOST EFFECTIVE OPERATING TEMPERATURES	+59°	+15°		-5%	EXAMPLE 1 A "30 day" unit installed at 40° C will empty 20% faster (24 day discharge).
		+50°	+10°		-10%	
		+41°	+5°		-15%	
+32°		0°	-20%			
+23°		-5°	-25%			
+14°		-10°	-30%			
+3.2°		-16°	-35%			
-4.0°		-20°	-40%			
OPERATING TEMPERATURES		-14.8°	-26°	-45%	EXAMPLE 2 A "30 day" unit installed at -30° C has a 50% dispensing rate loss (45 day discharge).	
		-22°	-30°	-50%		
	-32.8°	-36°	-55%			
	-40°	-40°	-60%			

Adjustment for Altitude

The ELECTRO-LUBER™ operates in normal fashion at altitudes to 1000 feet above sea level. The dispensing rate will increase above 1000 feet due to reduced atmospheric pressure. For example, at 2000 feet the discharge rate will be 10% faster. For every additional 1000 feet of altitude the discharge rate will increase by an additional 5%. For applications at high elevations please request special instructions.

Special Conditions for Safe Use (ATEX Intrinsic Safety)

The apparatus must not be installed in a position where it may be subjected to an excessive air/fluid flow that could cause electrostatic charge to build up.

NOTE: Not responsible for consequential damage beyond replacement of ELECTRO-LUBER™ or refund of amount paid.

Selection of Switch Settings

One stroke from a typical grease gun is equal to approximately one cubic centimetre (cc). To select the switch setting appropriate for your application first look across the temperature row for the approximate ambient temperature for the application. For fluctuating temperature applications, take the average between the high and the low temperature. Next, look down the column for the desired output of lubricant, remembering that 1 cc is equal to approximately one stroke from a grease gun. The switch settings are shown in the left most column.

Mini Luber (125cc)

Lubricant output rates for various temperatures at altitudes from sea level to 1000 feet

Switch settings	+14°F		+32°F		+50°F		+68°F		+77°F		+86°F		+95°F		+113°F		+131°F	
	Daily output cc's	Days until empty	Daily output cc's	Days until empty	Daily output cc's	Days until empty	Daily output cc's	Days until empty	Daily output cc's	Days until empty	Daily output cc's	Days until empty	Daily output cc's	Days until empty	Daily output cc's	Days until empty	Daily output cc's	Days until empty
All	6.0	20	6.8	18	7.7	16	8.5	14.2	8.9	13	9.4	13	9.8	12	10.6	11	11.1	11
1	2.8	43	3.2	38	3.6	33	4.0	30	4.2	29	4.4	27	4.6	26	5.0	24	5.2	23
2	1.4	86	1.6	75	1.8	67	2.0	60	2.1	57	2.2	55	2.3	52	2.5	48	2.6	46
3	0.9	129	1.1	113	1.2	100	1.33	90	1.4	86	1.5	82	1.5	78	1.7	72	1.7	69
6+12	0.7	171	0.8	150	0.9	133	1.0	120	1.1	114	1.1	109	1.2	104	1.3	96	1.3	92
6+B	0.6	190	0.7	167	0.8	148	0.9	133	0.9	127	1.0	121	1.0	116	1.1	107	1.2	103
6	0.5	256	0.5	224	0.6	199	0.67	180	0.7	171	0.7	163	0.8	156	0.8	143	0.9	136
12+B	0.4	343	0.4	300	0.5	267	0.5	240	0.5	229	0.6	218	0.6	209	0.6	192	0.7	185
12	0.2	519	0.3	455	0.3	404	0.33	360	0.3	346	0.4	331	0.4	316	0.4	291	0.4	280

Budget Luber (250cc)

Lubricant output rates for various temperatures at altitudes from sea level to 1000 feet

Switch settings	+14°F		+32°F		+50°F		+68°F		+77°F		+86°F		+95°F		+113°F		+131°F	
	Daily output cc's	Days until empty	Daily output cc's	Days until empty	Daily output cc's	Days until empty	Daily output cc's	Days until empty	Daily output cc's	Days until empty	Daily output cc's	Days until empty	Daily output cc's	Days until empty	Daily output cc's	Days until empty	Daily output cc's	Days until empty
All	12.5	20	13.9	18	15.6	16	17.4	14.2	19.0	13	19.2	13	20.6	12	22.0	11	22.7	11
1	5.8	43	6.6	38	7.6	33	8.3	30	8.6	29	9.3	27	9.6	26	10.4	24	10.8	23
2	2.9	86	3.3	75	3.7	67	4.1	60	4.4	57	4.5	55	4.8	52	5.2	48	5.4	46
3	1.9	129	2.2	113	2.5	100	2.7	90	2.9	86	3.0	82	3.2	78	3.5	72	3.6	69
6+12	1.5	171	1.7	150	1.9	133	2.0	120	2.2	114	2.3	109	2.4	104	2.6	96	2.7	92
6+B	1.3	190	1.5	167	1.7	148	1.8	133	2.0	127	2.1	121	2.2	116	2.3	107	2.4	103
6	1.0	256	1.1	224	1.3	199	1.3	180	1.5	171	1.5	163	1.6	156	1.7	143	1.8	136
12+B	0.7	343	0.8	300	0.9	267	1.0	240	1.1	229	1.1	218	1.2	209	1.3	192	1.4	185
12	0.5	519	0.6	455	0.6	404	0.7	360	0.7	346	0.8	331	0.8	316	0.9	291	0.9	280

Jumbo Luber (475cc)

Lubricant output rates for various temperatures at altitudes from sea level to 1000 feet

Switch settings	+14°F		+32°F		+50°F		+68°F		+77°F		+86°F		+95°F		+113°F		+131°F	
	Daily output cc's	Days until empty	Daily output cc's	Days until empty	Daily output cc's	Days until empty	Daily output cc's	Days until empty	Daily output cc's	Days until empty	Daily output cc's	Days until empty	Daily output cc's	Days until empty	Daily output cc's	Days until empty	Daily output cc's	Days until empty
All	22.3	20	25.5	18	28.7	16	31.8	14.2	33.5	13	35.1	13	36.7	12	39.8	11	43.5	10
1	10.5	43	12.0	37	13.5	33	15.0	30	15.8	28	16.5	27	17.3	26	18.8	24	20.5	22
2	5.3	85	6.0	74	6.8	66	7.5	60	7.9	57	8.3	54	8.6	52	9.4	48	10.2	44
3	3.5	128	4.0	112	4.5	99	5.0	90	5.3	85	5.5	81	5.8	78	6.3	71	6.8	65
6+12	2.6	171	3.0	150	3.4	133	3.7	120	3.9	114	4.1	109	4.3	104	4.7	96	5.1	88
6+B	2.4	190	2.7	166	3.0	148	3.4	133	3.5	127	3.7	121	3.9	116	4.2	106	4.6	97
6	1.8	255	2.0	223	2.3	198	2.5	180	2.6	170	2.8	162	2.9	155	3.1	143	3.4	131
12+B	1.3	337	1.5	295	1.7	262	1.9	240	2.0	225	2.1	214	2.2	205	2.4	189	2.6	173
12	0.9	510	1.0	447	1.1	397	1.25	360	1.3	340	1.4	325	1.4	311	1.6	286	1.7	262

Note: Please refer to previous page for temperature and altitude adjustments

For other settings or special applications, please consult the factory
or your Electro-Lube Sales Representative

Patents: US #4023648, #4671386 Canada #101490 Britain #1496841 Japan #1011803 Germany #DE 2520241 C3

Certified Intrinsically Safe for Class I, Groups A,B,C,D; Class II, Groups E,F,G; Class III CSA #LR 51732-8, UL #E149679
MSHA # 2G-4081-0, Energy, Mines & Resources Canada – For use in Hazardous Locations Certificate # 600

 II 1 G EEx ia IIC T3 (-40°C to +55°C)  IM1 EEx ia I (-40°C to +55°C)

Certificate # MECS 00 ATEX 4229X, BAS 00 ATEX 1228X

Standards: EN50014: Amds 1&2; EN50020: 1994; EN50284: 1999; prEN50303: 1999

BS EN ISO 9001:2000
FM 66860

ATS Electro-Lube International, Inc.

7388 Wilson Ave., Tilbury Industrial Park
Delta, B.C. V4G 1H3 CANADA
Phone: (604)946-1308 Fax: (604)946-0427

E.&O.E. rev 02/10

FACTORY DIRECT

Phone: **800-663-8141** Fax: **800-663-8140**

Not responsible for damage or consequential damage beyond replacement or refund of amount paid.
En cas de dommage, la responsabilité d'A.T.S. se limite au remplacement ou au remboursement de l'appareil